

POLE COMPONENT INFORMATION			
ITEM	QTY.	DESCRIPTION	WT. EACH
1	1	STEEL POLE TOP SECTION 47'-6" LONG	3,500
2	1	STEEL POLE BOTTOM SECTION 32'-6" LONG	4,750
TOTAL WEIGHT			8,250 LB

ALL OF OUR INVENTORY CAN BE MODIFIED TO FIT YOUR SPECIFICATIONS, INCLUDING VANGS, ARM CONNECTIONS, GROUNDING, AND PRE-DRILLED HOLES.

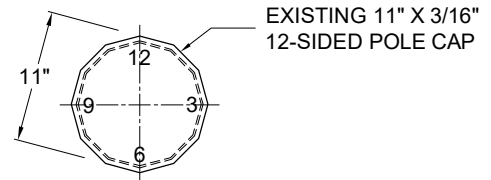

SECTION A-A
POLE CAP

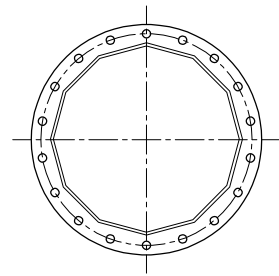

SECTION B-B
FLANGE PLATE

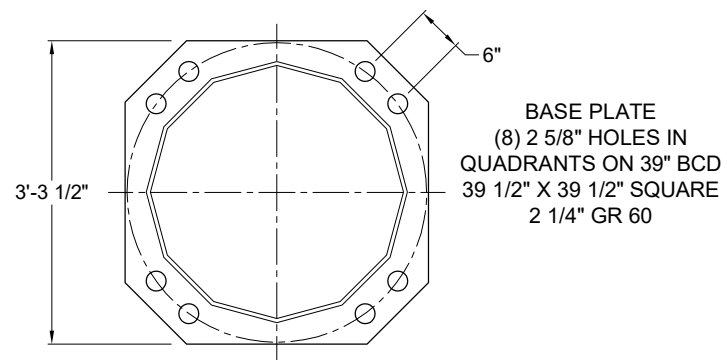

SECTION C-C
BASE PLATE

80FT CORTEN
POLE TYPE: PP80
POLE WEIGHT: 8,250 LB
(15) AVAILABLE

